

SN65C1406, SN75C1406 TRIPLE LOW-POWER DRIVERS/RECEIVERS

SLLS148E – MAY 1990 – REVISED OCTOBER 2001

- Meet or Exceed the Requirements of TIA/EIA-232-F and ITU Recommendation V.28
- Very Low Power Consumption . . . 5 mW Typ
- Wide Driver Supply Voltage Range . . . ± 4.5 V to ± 15 V
- Driver Output Slew Rate Limited to 30 V/ μ s Max
- Receiver Input Hysteresis . . . 1000 mV Typ
- Push-Pull Receiver Outputs
- On-Chip Receiver 1- μ s Noise Filter
- Functionally Interchangeable With Motorola MC145406 and Texas Instruments TL145406
- Package Options Include Plastic Small-Outline (D, DW, NS) Packages and DIPs (N)

SN65C1406 . . . D PACKAGE
SN75C1406 . . . D, DW, N, OR NS PACKAGE
(TOP VIEW)

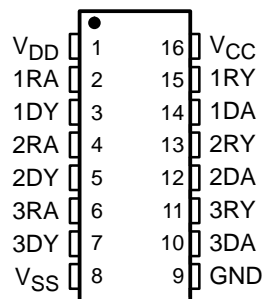

description

The SN65C1406 and SN75C1406 are low-power BiMOS devices containing three independent drivers and receivers that are used to interface data terminal equipment (DTE) with data circuit-terminating equipment (DCE). These devices are designed to conform to TIA/EIA-232-F. The drivers and receivers of the SN65C1406 and SN75C1406 are similar to those of the SN75C188 quadruple driver and SN75C189A quadruple receiver, respectively. The drivers have a controlled output slew rate that is limited to a maximum of 30 V/ μ s, and the receivers have filters that reject input noise pulses shorter than 1 μ s. Both these features eliminate the need for external components.

The SN65C1406 and SN75C1406 are designed using low-power techniques in a BiMOS technology. In most applications, the receivers contained in these devices interface to single inputs of peripheral devices such as ACEs, UARTs, or microprocessors. By using sampling, such peripheral devices are usually insensitive to the transition times of the input signals. If this is not the case, or for other uses, it is recommended that the SN65C1406 and SN75C1406 receiver outputs be buffered by single Schmitt input gates or single gates of the HCMOS, ALS, or 74F logic families.

The SN65C1406 is characterized for operation from -40°C to 85°C . The SN75C1406 is characterized for operation from 0°C to 70°C .

AVAILABLE OPTIONS

T _A	PACKAGED DEVICES			
	SMALL OUTLINE (D)	SMALL OUTLINE (DW)	PLASTIC DIP (N)	PLASTIC SMALL OUTLINE (NS)
-40°C to 85°C	SN65C1406D	—	—	—
0°C to 70°C	SN75C1406D	SN75C1406DW	SN75C1406N	SN75C1406NS

The D, DW, and PW packages are available taped and reeled. Add the suffix R to device type (e.g., SN75C1406DR).



Please be aware that an important notice concerning availability, standard warranty, and use in critical applications of Texas Instruments semiconductor products and disclaimers thereto appears at the end of this data sheet.

PRODUCTION DATA information is current as of publication date. Products conform to specifications per the terms of Texas Instruments standard warranty. Production processing does not necessarily include testing of all parameters.

 **TEXAS
INSTRUMENTS**

POST OFFICE BOX 655303 • DALLAS, TEXAS 75265

Copyright © 2001, Texas Instruments Incorporated

SN65C1406, SN75C1406 TRIPLE LOW-POWER DRIVERS/RECEIVERS

SLLS148E – MAY 1990 – REVISED OCTOBER 2001

logic diagram (positive logic)

Typical of Each Receiver

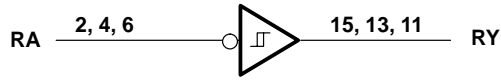

Typical of Each Driver

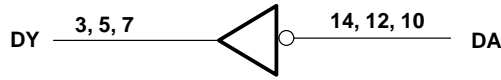

schematics of inputs and outputs

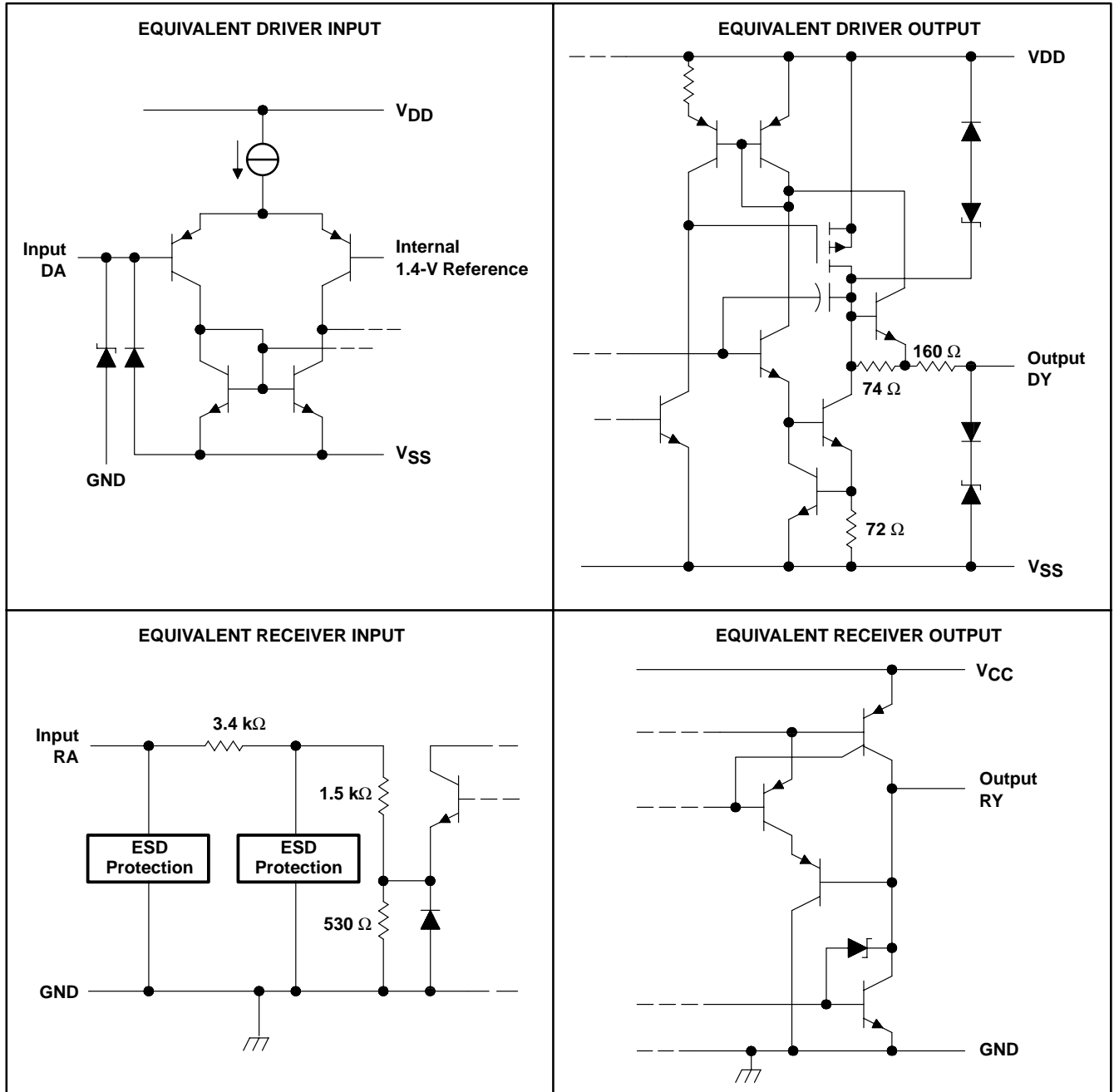

All resistor values shown are nominal.

SN65C1406, SN75C1406 TRIPLE LOW-POWER DRIVERS/RECEIVERS

SLLS148E – MAY 1990 – REVISED OCTOBER 2001

absolute maximum ratings over operating free-air temperature range (unless otherwise noted)†

Supply voltage: V_{DD} (see Note 1)	15 V
V_{SS}	-15 V
V_{CC}	7 V
Input voltage range, V_I : Driver	V_{SS} to V_{DD}
Receiver	-30 V to 30 V
Output voltage range, V_O : Driver	$(V_{SS} - 6 V)$ to $(V_{DD} + 6 V)$
Receiver	-0.3 V to $(V_{CC} + 0.3 V)$
Package thermal impedance, θ_{JA} (see Note 2): D package	73°C/W
DW package	57°C/W
N package	67°C/W
NS package	64°C/W
Lead temperature 1,6 mm (1/16 inch) from case for 10 seconds	260°C
Storage temperature range, T_{stg}	-65°C to 150 °C

† Stresses beyond those listed under “absolute maximum ratings” may cause permanent damage to the device. These are stress ratings only, and functional operation of the device at these or any other conditions beyond those indicated under “recommended operating conditions” is not implied. Exposure to absolute-maximum-rated conditions for extended periods may affect device reliability.

- NOTES: 1. All voltages are with respect to the network ground terminal.
2. The package thermal impedance is calculated in accordance with JESD 51-7.

recommended operating conditions

		MIN	NOM	MAX	UNIT
V_{DD}	Supply voltage	4.5	12	15	V
V_{SS}	Supply voltage	-4.5	-12	-15	V
V_{CC}	Supply voltage	4.5	5	6	V
V_I	Input voltage	Driver	$V_{SS}+2$	V_{DD}	V
		Receiver		± 25	
V_{IH}	High-level input voltage	2			V
V_{IL}	Low-level input voltage			0.8	V
I_{OH}	High-level output current			-1	mA
I_{OL}	Low-level output current			3.2	mA
T_A	Operating free-air temperature	SN65C1406	-40	85	°C
		SN75C1406	0	70	



DRIVER SECTION

electrical characteristics over operating free-air temperature range, $V_{DD} = 12\text{ V}$, $V_{SS} = -12\text{ V}$, $V_{CC} = 5\text{ V} \pm 10\%$ (unless otherwise noted)

PARAMETER		TEST CONDITIONS		MIN	TYP†	MAX	UNIT
V _{OH}	High-level output voltage	V _{IH} = 0.8 V, R _L = 3 k Ω , See Figure 1	V _{DD} = 5 V, V _{SS} = -5 V	4	4.5		V
			V _{DD} = 12 V, V _{SS} = -12 V	10	10.8		
V _{OL}	Low-level output voltage (see Note 3)	V _{IH} = 2 V, R _L = 3 k Ω , See Figure 1	V _{DD} = 5 V, V _{SS} = -5 V		-4.4	-4	V
			V _{DD} = 12 V, V _{SS} = -12 V		-10.7	-10	
I _{IH}	High-level input current	V _I = 5 V, See Figure 2				1	μA
I _{IL}	Low-level input current	V _I = 0, See Figure 2				-1	μA
I _{OS(H)}	High-level short-circuit output current‡	V _I = 0.8 V, V _O = 0 or V _{SS} , See Figure 1		-7.5	-12	-19.5	mA
I _{OS(L)}	Low-level short-circuit output current‡	V _I = 2 V, V _O = 0 or V _{DD} , See Figure 1		7.5	12	19.5	mA
I _{DD}	Supply current from V _{DD}	No load, All inputs at 2 V or 0.8 V	V _{DD} = 5 V, V _{SS} = -5 V		115	250	μA
			V _{DD} = 12 V, V _{SS} = -12 V		115	250	
I _{SS}	Supply current from V _{SS}	No load, All inputs at 2 V or 0.8 V	V _{DD} = 5 V, V _{SS} = -5 V		-115	-250	μA
			V _{DD} = 12 V, V _{SS} = -12 V		-115	-250	
r _O	Output resistance	V _{DD} = V _{SS} = V _{CC} = 0, See Note 4	V _O = -2 V to 2 V,	300	400		Ω

† All typical values are at T_A = 25°C.

‡ Not more than one output should be shorted at a time.

NOTES: 3. The algebraic convention, where the more positive (less negative) limit is designated as maximum, is used in this data sheet for logic levels only.

4. Test conditions are those specified by TIA/EIA-232-F.

switching characteristics at T_A = 25°C, V_{DD} = 12 V, V_{SS} = -12 V, V_{CC} = 5 V \pm 10%

PARAMETER		TEST CONDITIONS		MIN	TYP	MAX	UNIT
t _{PLH}	Propagation delay time, low- to high-level output§	R _L = 3 k Ω to 7 k Ω , C _L = 15 pF, See Figure 3			1.2	3	μs
t _{PHL}	Propagation delay time, high- to low-level output§	R _L = 3 k Ω to 7 k Ω , C _L = 15 pF, See Figure 3			2.5	3.5	μs
t _{TLH}	Transition time, low- to high-level output¶	R _L = 3 k Ω to 7 k Ω , C _L = 15 pF, See Figure 3		0.53	2	3.2	μs
t _{THL}	Transition time, high- to low-level output¶	R _L = 3 k Ω to 7 k Ω , C _L = 15 pF, See Figure 3		0.53	2	3.2	μs
t _{TLH}	Transition time, low- to high-level output#	R _L = 3 k Ω to 7 k Ω , C _L = 2500 pF, See Figure 3			1	2	μs
t _{THL}	Transition time, high- to low-level output#	R _L = 3 k Ω to 7 k Ω , C _L = 2500 pF, See Figure 3			1	2	μs
SR	Output slew rate	R _L = 3 k Ω to 7 k Ω , C _L = 15 pF, See Figure 3		4	10	30	V/ μs

§ t_{PHL} and t_{PLH} include the additional time due to on-chip slew rate and are measured at the 50% points.

¶ Measured between 10% and 90% points of output waveform

Measured between 3-V and -3-V points of output waveform (TIA/EIA-232-F conditions) with all unused inputs tied either high or low

SN65C1406, SN75C1406 TRIPLE LOW-POWER DRIVERS/RECEIVERS

SLLS148E – MAY 1990 – REVISED OCTOBER 2001

RECEIVER SECTION

electrical characteristics over operating free-air temperature range, $V_{DD} = 12\text{ V}$, $V_{SS} = -12\text{ V}$, $V_{CC} = 5\text{ V} \pm 10\%$ (unless otherwise noted)

PARAMETER		TEST CONDITIONS	MIN	TYP†	MAX	UNIT
V_{IT+}	Positive-going input threshold voltage	See Figure 5	1.7	2	2.55	V
V_{IT-}	Negative-going input threshold voltage	See Figure 5	0.65	1	1.25	V
V_{hys}	Input hysteresis voltage ($V_{IT+} - V_{IT-}$)		600	1000		mV
V_{OH}	High-level output voltage	$V_I = 0.75\text{ V}$, $I_{OH} = -20\text{ }\mu\text{A}$, See Figure 5 and Note 5	3.5			V
		$V_I = 0.75\text{ V}$, $I_{OH} = -1\text{ mA}$, See Figure 5	$V_{CC} = 4.5\text{ V}$	2.8	4.4	
			$V_{CC} = 5\text{ V}$	3.8	4.9	
		$V_{CC} = 5.5\text{ V}$	4.3	5.4		
V_{OL}	Low-level output voltage	$V_I = 3\text{ V}$, $I_{OL} = 3.2\text{ mA}$, See Figure 5		0.17	0.4	V
I_{IH}	High-level input current	$V_I = 2.5\text{ V}$	3.6	4.6	8.3	mA
		$V_I = 3\text{ V}$	0.43	0.55	1	
I_{IL}	Low-level input current	$V_I = -2.5\text{ V}$	-3.6	-5	-8.3	mA
		$V_I = -3\text{ V}$	-0.43	-0.55	-1	
$I_{OS(H)}$	High-level short-circuit output current	$V_I = 0.75\text{ V}$, $V_O = 0$, See Figure 4		-8	-15	mA
$I_{OS(L)}$	Low-level short-circuit output current	$V_I = V_{CC}$, $V_O = V_{CC}$, See Figure 4		13	25	mA
I_{CC}	Supply current from V_{CC}	No load, All inputs at 0 or 5 V	$V_{DD} = 5\text{ V}$, $V_{SS} = -5\text{ V}$	320	450	μA
			$V_{DD} = 12\text{ V}$, $V_{SS} = -12\text{ V}$	320	450	

† All typical values are at $T_A = 25^\circ\text{C}$.

NOTE 5: If the inputs are left unconnected, the receiver interprets this as an input low and the receiver outputs remain in the high state.

switching characteristics at $T_A = 25^\circ\text{C}$, $V_{DD} = 12\text{ V}$, $V_{SS} = -12\text{ V}$, $V_{CC} = 5\text{ V} \pm 10\%$ (unless otherwise noted)

PARAMETER		TEST CONDITIONS	MIN	TYP	MAX	UNIT
t_{PLH}	Propagation delay time, low- to high-level output	$C_L = 50\text{ pF}$, $R_L = 5\text{ k}\Omega$, See Figure 6		3	4	μs
t_{PHL}	Propagation delay time, high- to low-level output	$C_L = 50\text{ pF}$, $R_L = 5\text{ k}\Omega$, See Figure 6		3	4	μs
t_{TLH}	Transition time, low- to high-level output‡	$C_L = 50\text{ pF}$, $R_L = 5\text{ k}\Omega$, See Figure 6		300	450	ns
t_{THL}	Transition time, high- to low-level output‡	$C_L = 50\text{ pF}$, $R_L = 5\text{ k}\Omega$, See Figure 6		100	300	ns
$t_{W(N)}$	Duration of longest pulse rejected as noise§	$C_L = 50\text{ pF}$, $R_L = 5\text{ k}\Omega$	1		4	μs

‡ Measured between 10% and 90% points of output waveform

§ The receiver ignores any positive- or negative-going pulse that is less than the minimum value of $t_{W(N)}$ and accepts any positive- or negative-going pulse greater than the maximum of $t_{W(N)}$.



PARAMETER MEASUREMENT INFORMATION

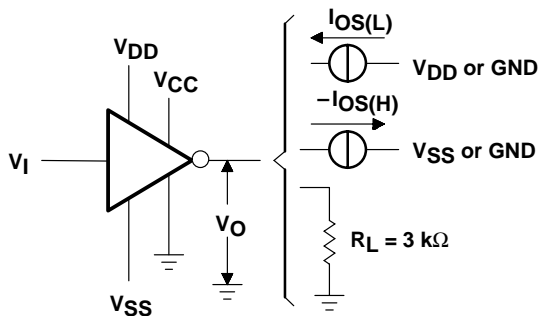

Figure 1. Driver Test Circuit
 V_{OH} , V_{OL} , $I_{OS(L)}$, $I_{OS(H)}$

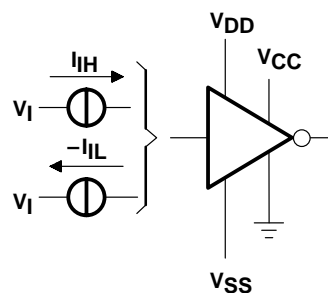
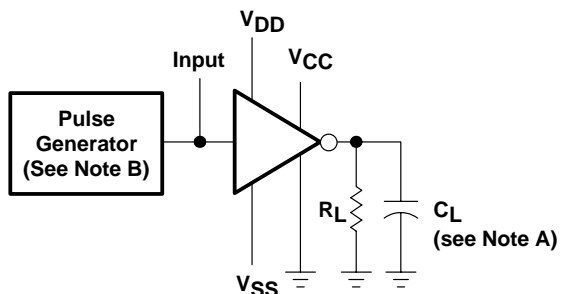
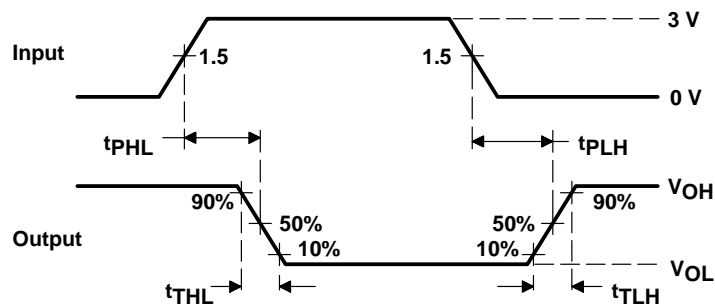

Figure 2. Driver Test Circuit, I_{iL} , I_{iH}



TEST CIRCUIT



VOLTAGE WAVEFORMS

NOTES: A. C_L includes probe and jig capacitance.
B. The pulse generator has the following characteristics: $t_w = 25 \mu s$, $PRR = 20 \text{ kHz}$, $Z_O = 50 \Omega$, $t_r = t_f < 50 \text{ ns}$.

Figure 3. Driver Test Circuit and Voltage Waveforms

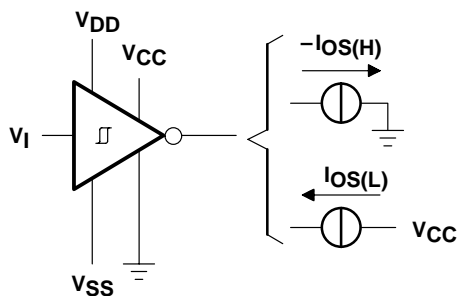

Figure 4. Receiver Test Circuit, $I_{OS(H)}$, $I_{OS(L)}$

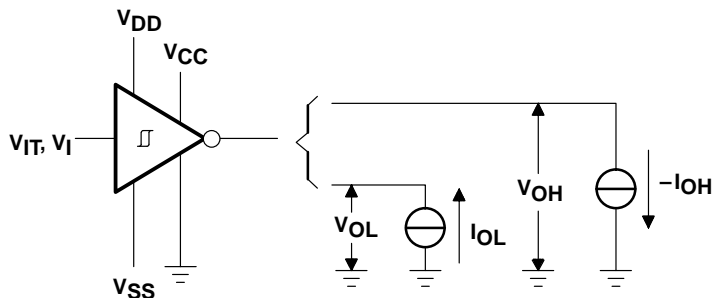
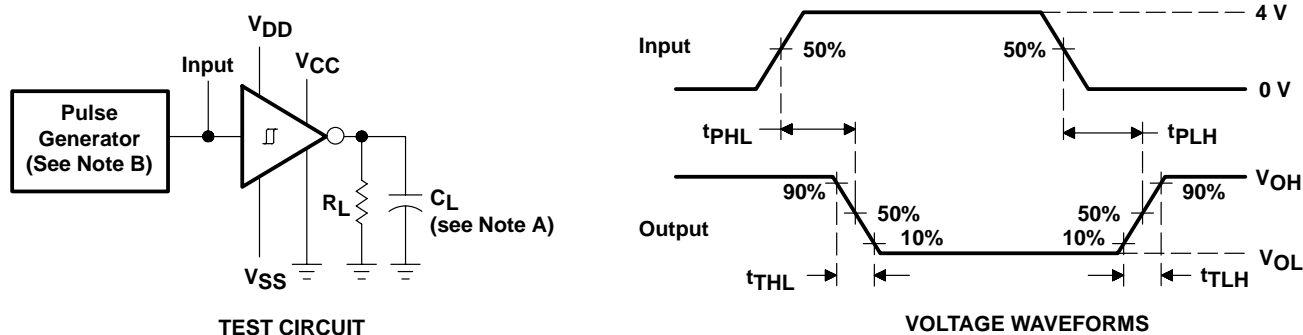

Figure 5. Receiver Test Circuit, V_{IT} , V_{OL} , V_{OH}

SN65C1406, SN75C1406 TRIPLE LOW-POWER DRIVERS/RECEIVERS

SLLS148E – MAY 1990 – REVISED OCTOBER 2001

PARAMETER MEASUREMENT INFORMATION



NOTES: C. C_L includes probe and jig capacitance.
D. The pulse generator has the following characteristics: $t_w = 25 \mu s$, $PRR = 20 \text{ kHz}$, $Z_O = 50 \Omega$, $t_r = t_f < 50 \text{ ns}$.

Figure 6. Receiver Test Circuit and Voltage Waveforms

APPLICATION INFORMATION

The TIA/EIA-232-F specification is for data interchange between a host computer and a peripheral at signaling rates up to 20 kbit/s. Many TIA/EIA-232-F devices will operate at higher data rates with lower capacitive loads (short cables). For reliable operation at greater than 20 kbit/s, the designer needs to have control of both ends of the cable. By mixing different types of TIA/EIA-232-F devices and cable lengths, errors can occur at higher frequencies (above 20 kbit/s). When operating within the TIA/EIA-232-F requirements of less than 20 kbit/s and with compliant line circuits, interoperability is assured. For applications operating above 20 kbit/s, the design engineer should consider devices and system designs that meet the TIA/EIA-232-F requirements.

IMPORTANT NOTICE

Texas Instruments Incorporated and its subsidiaries (TI) reserve the right to make corrections, modifications, enhancements, improvements, and other changes to its products and services at any time and to discontinue any product or service without notice. Customers should obtain the latest relevant information before placing orders and should verify that such information is current and complete. All products are sold subject to TI's terms and conditions of sale supplied at the time of order acknowledgment.

TI warrants performance of its hardware products to the specifications applicable at the time of sale in accordance with TI's standard warranty. Testing and other quality control techniques are used to the extent TI deems necessary to support this warranty. Except where mandated by government requirements, testing of all parameters of each product is not necessarily performed.

TI assumes no liability for applications assistance or customer product design. Customers are responsible for their products and applications using TI components. To minimize the risks associated with customer products and applications, customers should provide adequate design and operating safeguards.

TI does not warrant or represent that any license, either express or implied, is granted under any TI patent right, copyright, mask work right, or other TI intellectual property right relating to any combination, machine, or process in which TI products or services are used. Information published by TI regarding third-party products or services does not constitute a license from TI to use such products or services or a warranty or endorsement thereof. Use of such information may require a license from a third party under the patents or other intellectual property of the third party, or a license from TI under the patents or other intellectual property of TI.

Reproduction of information in TI data books or data sheets is permissible only if reproduction is without alteration and is accompanied by all associated warranties, conditions, limitations, and notices. Reproduction of this information with alteration is an unfair and deceptive business practice. TI is not responsible or liable for such altered documentation.

Resale of TI products or services with statements different from or beyond the parameters stated by TI for that product or service voids all express and any implied warranties for the associated TI product or service and is an unfair and deceptive business practice. TI is not responsible or liable for any such statements.

Mailing Address:

Texas Instruments
Post Office Box 655303
Dallas, Texas 75265